

**ferrum**

**PROVEN CONTINUITY  
PUSHER CENTRIFUGES**



---

### **FERRUM PROCESS SYSTEMS LTD.**

Industriestrasse 11  
5503 Schafisheim  
Switzerland

T +41 62 889 14 11  
centrifuges@ferrum.net  
www.ferrum.net

---

### **FERRUM PROCESS SYSTEMS INC.**

11414 W. Park Place  
Suite 202  
Milwaukee, WI 53224  
USA

T +1 877 933 3778  
F +1 877 711 2329  
sales@ferrumUS.com  
www.ferrumUS.com

---

### **FERRUM PROCESS SYSTEMS (KUNSHAN) CO., LTD.**

No. 329, Jujin Road  
Zhangpu Township  
215321 Kunshan City  
Jiangsu Province  
P.R. China

T +86 512 3662 5403  
F +86 512 3662 5100  
centrifuge@ferrumChina.com  
www.ferrumChina.com

---

### **HILLER GMBH**

Schwalbenholzstrasse 2  
84137 Vilsbiburg  
Germany

T +49 8741 48 0  
F +49 8741 48 139  
info@hillerzentr.de  
www.hillerzentr.de

---

### **SPOMASZ-WRONKI GRUPA FERRUM SP. Z O.O.**

ul. Powstańców Wlkp. 23  
64-510 Wronki  
Poland

T +48 672 545 169  
handel@spomasz-wronki.com.pl  
www.spomasz-wronki.com.pl

**FERRUM** MORE THAN **100** YEARS  
SINCE **1917**



# APPLICATIONS SPECIFIC DESIGNS

## CHEMICALS

---

### + Chlorides

- Sodium chloride
- Potassium chloride
- Ammonium chloride
- Lithium chloride

### + Sulphates

- Copper sulphate pentahydrate
- Iron sulphate heptahydrate
- Magnesium sulphate monohydrate
- Magnesium sulphate heptahydrate
- Nickel sulphate dihydrate
- Nickel sulphate hexahydrate
- Zinc sulphate
- Zinc sulphate monohydrate
- Zinc sulphate heptahydrate
- Potassium sulphate
- Lithium sulphate
- Sodium sulphate anhydride
- Sodium sulphate decahydrate
- Ammonium sulphate

### + Chlorates

- Sodium chlorate
- Potassium chlorate

### + Nitrates

- Sodium nitrate
- Potassium nitrate
- Lysine

### + Urea

- Urea, diff. Processes

### + Intermediate Products

- Sodium bicarbonate crude
- Sodium carbonate monohydrate

### + Fibrous Products

- Nitrocellulose
- Chips / Fibers

### + Phosphates

- MKP, MAP

### + Various

- Calcium tartrate
- Lithium hydroxide anhydrous
- Lithium hydroxide monohydrate
- Boric acid
- Tartaric acid

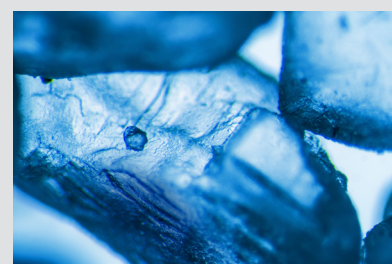
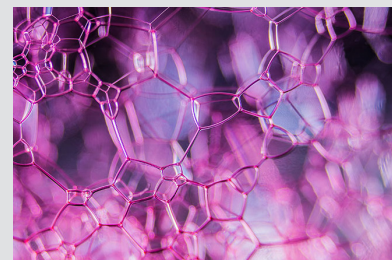

## FINE CHEMICAL/PHARMA

---

### + Fine Chemicals

- Sodium bicarbonate refined
- Sodium cyanide

### + Pharmaceuticals

- Sodium chloride

### + Sugar

- Dextrose, Fructose

## MINERAL PROCESSING

---

### + Mining

- Rock phosphate
- Rock salt (NaCl)
- Potassium chloride from Crystallization or Flotation

## PETROCHEMICALS

---

### + Basic Products

- Adipic acid
- Bisphenol A
- Caprolactam
- Paraxylene
- ABS, MBS
- Polyethylene
- PP

## FOOD

---

- Sodium chloride

## WASTE WATER

---

- Sewage

## ENVIRONMENTAL

---

- Sewage sludge
- PET, PP

# PUSHER CENTRIFUGE PM-23

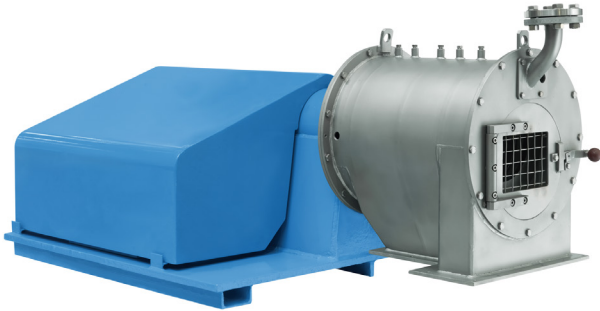

## MECHANICAL DESIGN

Based on the very successful Sulzer-Escher Wyss design, Ferrum has consistently developed the pusher centrifuge further, always in accordance with the latest requirements.

The simple, robust construction is very easy to maintain and permits straightforward commissioning as well as reliable, high performance continuous operation.

The rotary drive and pusher drive for the baskets are powered by two separate electric motors with stepped v-belt pulleys. The rotation of the pusher motor is converted into the pusher movement via a gearbox with an excenter wheel.

## DESIGN FEATURES

- + Simple, robust design, high reliability
- + High throughputs under the toughest conditions
- + Purely mechanical pusher drive without hydraulic system
- + Optimally designed inlet section for gentle acceleration of the product
- + Adjustable wash nozzles for optimum cake washing
- + Rinsing connections for easy cleaning of the centrifuge process area
- + Various discharge systems for gentle discharge of the solids
- + Various peripheral components available for the basic model
- + Special designs on request (gas-tight, explosion protection, etc.)

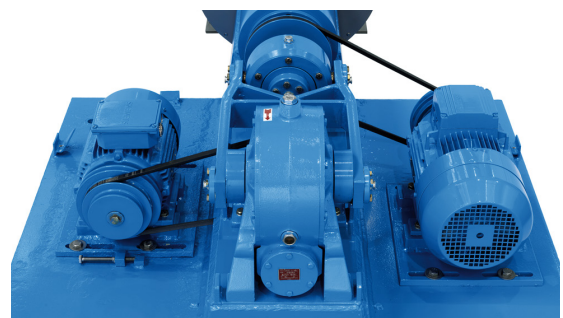

Drive and control unit PM-23

# PUSHER CENTRIFUGE TYPE P-32 TO P-120

## MODEL RANGE P-32 TO P-50

---

The centrifuge types P-32 to P-50 are a new development by Ferrum. Thanks to their high-performance hydraulics, the machines feature compact dimensions and can be operated with a small hydraulic oil volume.

The pusher mechanism is actuated hydraulically, reversal is effected via an external hydraulic control unit. The stroke frequency can be adjusted whilst the stroke length remains constant. The oil pump and the rotor are actuated using two separate electric motors.

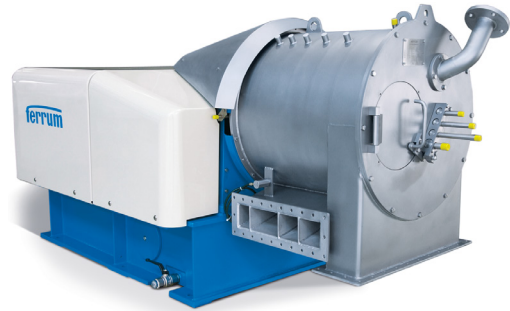

## MODEL RANGE P-60 TO P-120

---

Based on the very successful Sulzer-Escher Wyss design, Ferrum has consistently further developed the centrifuge types P-60 to P-120, in accordance with the latest requirements.

The pusher mechanism is actuated hydraulically, reversal is effected via a fully internal reversal unit. The stroke frequency can be adjusted whilst the stroke length remains constant. The oil pump and the rotor are actuated using two separate electric motors.

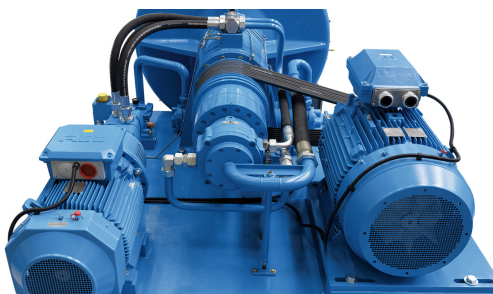
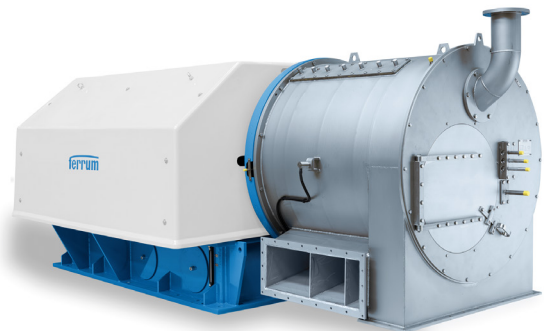

Drive and control unit P-100

## DESIGN FEATURES

---

- + Compact, robust and reliable design
- + Operation with a small hydraulic oil volume
- + High throughputs under the toughest conditions
- + Hydraulic pusher drive for high pusher forces
- + Optimally designed inlet section for gentle acceleration of the product
- + Adjustable wash nozzles for optimum cake washing
- + Rinsing connections for easy cleaning of the centrifuge process area
- + Various discharge systems for gentle solid discharge
- + Various peripheral components available for the basic model
- + Special designs on request (gas-tight, explosion protection, etc.)

# EXEMPLARY EFFICIENCY

## PRINCIPLE OF OPERATION

Pusher centrifuges are continuously operating filter centrifuges and can have several basket stages depending on the application and have one product discharge area. The solid-liquid separation shown here demonstrates a two-stage pusher centrifuge. Periodic rinsing of the process area is achieved by means of integrated rinsing nozzles and pipes.

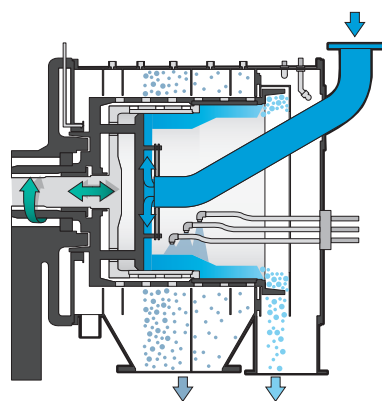

Solid-liquid separation

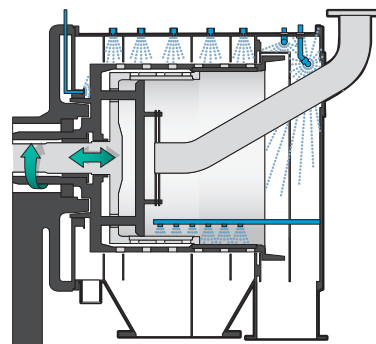

Rinsing the process area

### SOLID-LIQUID SEPARATION

**Suspension inlet** | The centrifuge is continuously fed with the suspension to be separated (solid-liquid mixture) via the inlet pipe. In case of poor flow characteristics, the feed is effected via an inlet screw conveyor (not shown).

**Suspension distributor** | The distributor accelerates and distributes the suspension over the entire periphery of the sieves in the filling area of the first basket stage. Ferrum offers various application-specific distribution systems for even and gentle acceleration and distribution of the suspension.

**First basket stage** | The greatest part (approx. 80%) of the liquid is already filtered out in the feed zone of the first basket stage, where a stable cake forms. The first basket stage performs, along with a rotational, also an axial pusher movement (oscillation movement).

**Second basket stage** | The cake is pushed in annular sections by each pusher movement from the first to the second basket stage.

**Solids discharge** | After the second basket stage, the solids leave the centrifuge via the discharge channel and the solids housing. Depending on the application, different discharge systems are used.

**Product washing** | If necessary, impurities in the mother liquor are washed out. The wash liquid is applied continuously over the cake via several adjustable wash nozzles.

**Filtrate housing** | The filtrate (filtered mother liquor and wash liquid) is collected in the filtrate housing and drawn off. Depending on the application, different filtrate housings and filtrate cyclones are used.

**Filtrate separation** | If necessary, the filtrate can be drawn off separately in each filtrate zone by means of separation plates fitted in the filtrate housing and disposed of or reused (e.g. counterflow washing).

### RINSING THE PROCESS AREA

The centrifuge process area is cleaned using rinsing liquid supplied through optimally arranged cleaning nozzles

and a cleaning pipe. Periodic rinsing prevents the crystal formation in the sieves and deposits in the solids housing.

# D-ACT® PUSHER CENTRIFUGES

## TYPE PD-60 TO PD-100

The D-ACT® pusher centrifuge System Escher Wyss extends the application range of the pusher centrifuge selection towards products with good dewatering characteristics. Its mechanical basis is built upon the highly successful pusher centrifuge range type P-60 to P-100. The unique patented design of the D-ACT® pusher centrifuge leads to product discharge in both stroke directions resulting in substantially higher throughputs.

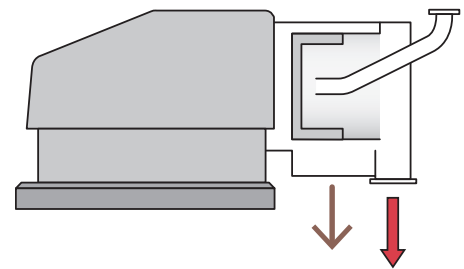

Standard pusher centrifuge

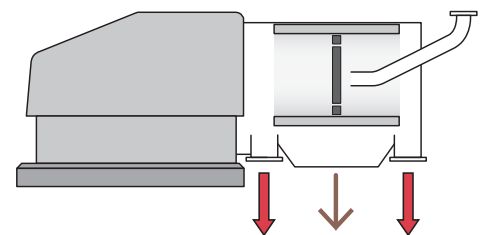

D-ACT® pusher centrifuge

### DESIGN FEATURES

- + Specially designed for products with medium to large particle size
- + Innovative suspension inlet zone where the cake is transported during both forward and return stroke
- + Compact, robust and reliable design
- + Rinsing connection for easy rinsing of the centrifuge process area
- + Adjustable wash nozzles for the cake washing
- + Various peripheral components available for the basic model
- + High availability

# ADVANTAGES

The D-ACT® pusher centrifuge achieves an up to 80% higher throughput compared to a standard 2-stage pusher centrifuge of the same size with an up to 20% lower specific energy consumption.

## ADVANTAGES OVER STANDARD PUSHER CENTRIFUGES

- + With the same stroke frequency up to 1.8 x the solids capacity resulting in a lower specific energy consumption
- + Lower solids content in the filtrate due to the reduced losses between pusher plate and sieve
- + Up to 80% higher throughput compared to a standard 2-stage pusher centrifuge of the same size
- + Up to 20% lower energy consumption compared to identically designed standard 2-stage pusher centrifuges
- + Lower specific foot print
- + Bearing and drive design of the centrifuge corresponds to the well-proven P-pusher centrifuge series
- + Higher throughput due to cake transport during both the forward and the return stroke

Comparison 2-stage pusher centrifuge / D-ACT® pusher centrifuge (with same basket diameter)

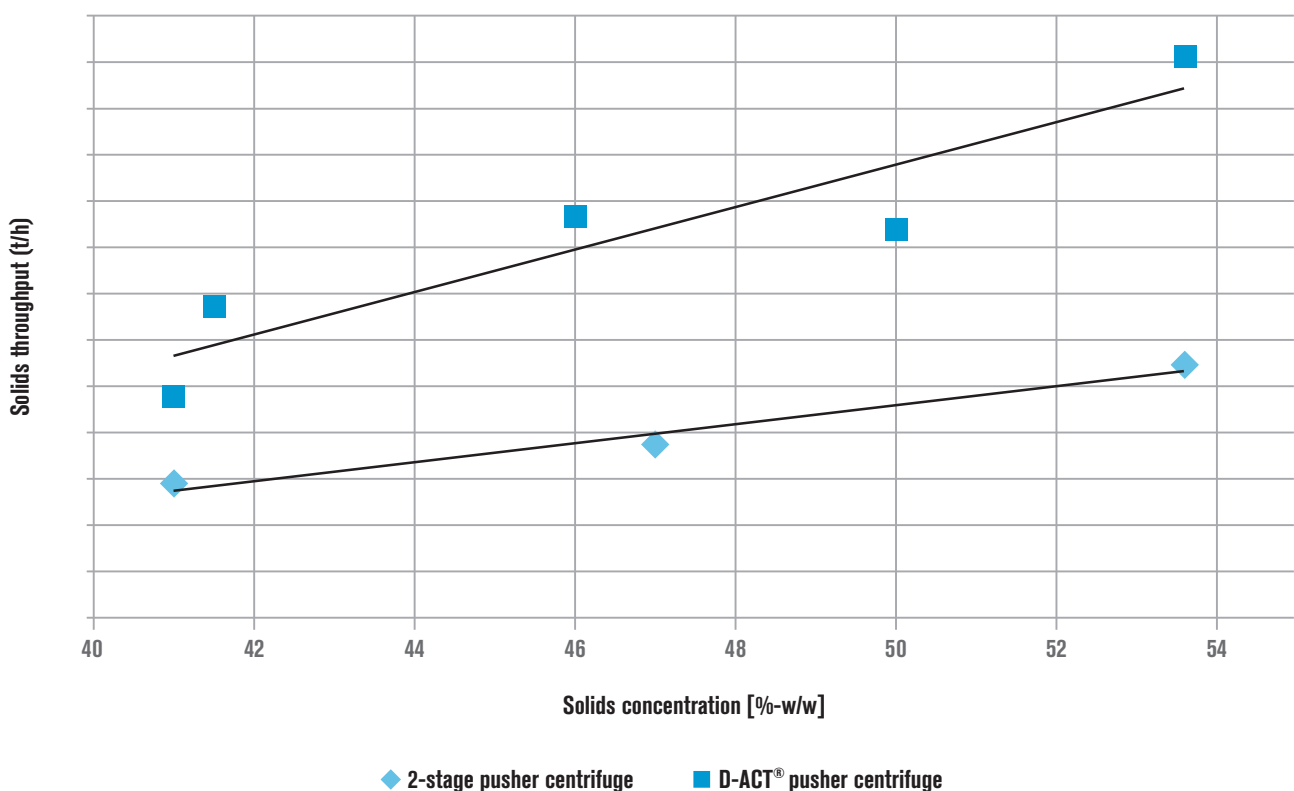



# DOUBLE ACTION

## PRINCIPLE OF OPERATION

D-ACT® pusher centrifuges are continuously operating filter centrifuges with a one-stage basket and two product discharge areas. Periodic rinsing of the process area is achieved by means of integrated rinsing nozzles and pipes.

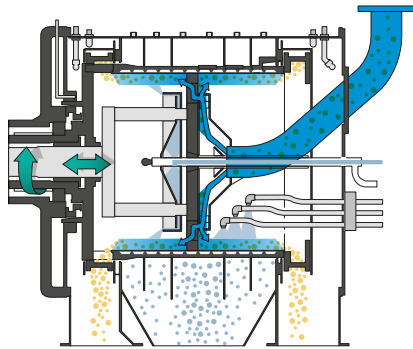

Solid-liquid separation

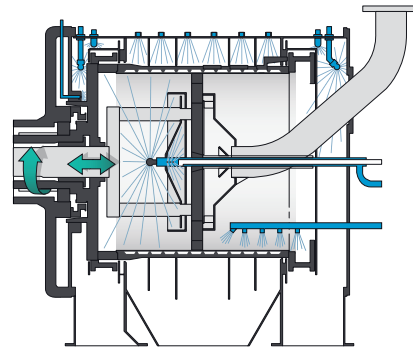

Rinsing the process area

### SOLID-LIQUID SEPARATION

**Suspension inlet** | The centrifuge is continuously fed with the suspension to be separated (solid-liquid mixture) via the inlet pipe.

**Suspension distributor** | The distributor accelerates and distributes the suspension over the entire periphery of the sieves in the filling area of the basket.

**Basket** | The greatest part (approx. 80%) of the liquid is already filtered out in the feed zone of the basket, where a stable cake forms. The pusher plate oscillates forward and backward and pushes the cake towards the rear AND front solids discharge.

**Solids discharge** | At EACH end of the basket, the solids leave the centrifuge via the discharge channels and the solids housing. Depending on the application, different discharge systems are used.

**Product washing** | If necessary, impurities in the mother liquor are washed out. The wash liquid is applied continuously over the cake via several adjustable wash nozzles on both sides of the pusher plate.

**Filtrate housing** | The filtrate (filtered mother liquor and wash liquid) is collected in the filtrate housing and drawn off. Depending on the application, different filtrate housings and filtrate cyclones are used.

### RINSING THE PROCESS AREA

The centrifuge process area is cleaned using rinsing liquid supplied through optimally arranged cleaning nozzles and

2 rinsing pipes. Periodic rinsing prevents crystal formation in the sieves and deposits in the solids housing.

# PRE-THICKENING AN IMPORTANT PROCESS STEP

As a continuously operating machine, the pusher centrifuge requires process conditions and solids concentrations as constant as possible to ensure optimum operation and consistent product quality.

For process and plant-related reasons, the necessary feed conditions are often not achieved. As a solution for this problem, Ferrum offers various pre-thickening systems and dosing devices.

Depending on requirements, Ferrum supplies the design, production and automation of the related system.

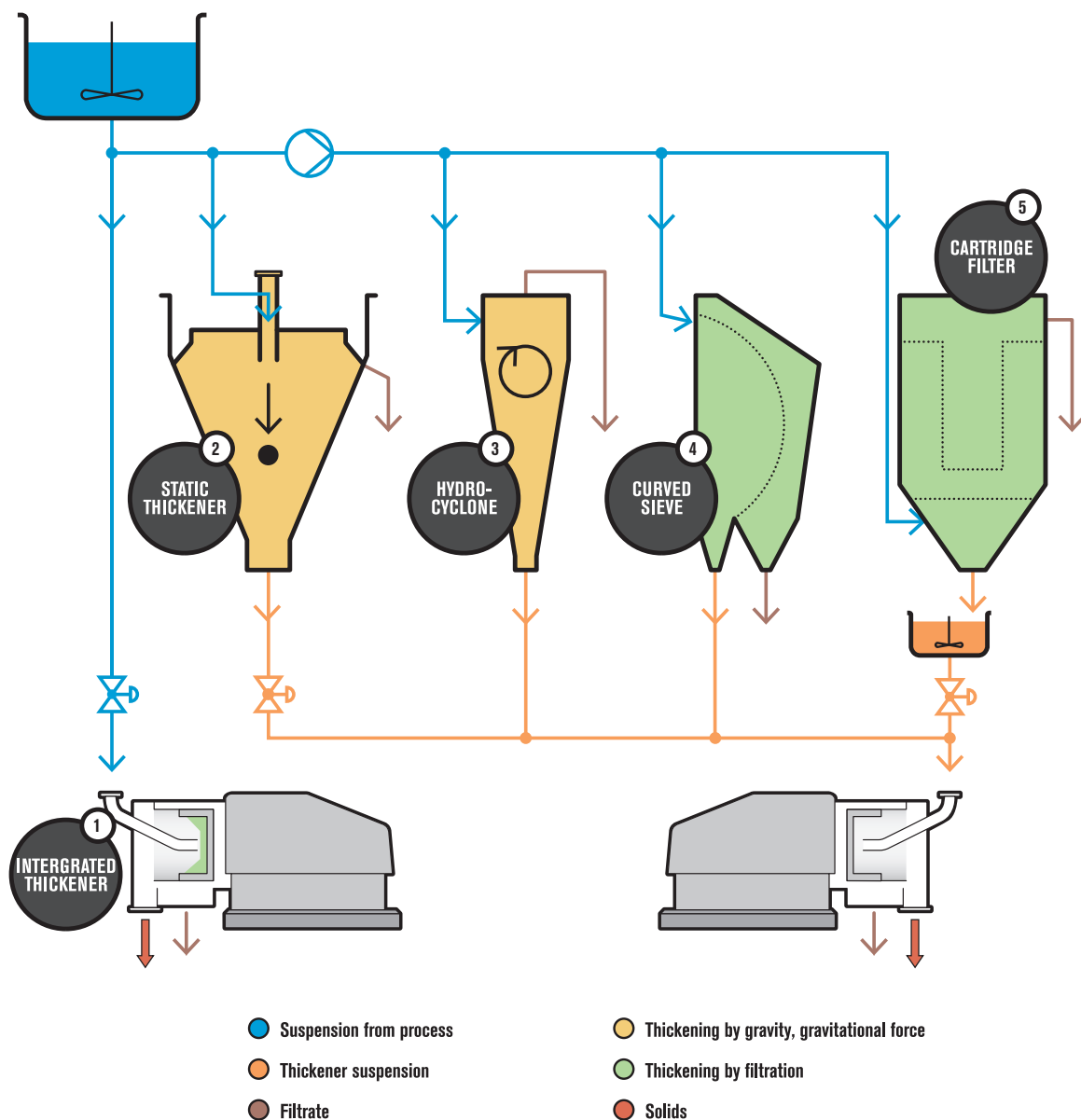



## 1. INTEGRATED THICKENER – A FERRUM INNOVATION

---

The integrated thickening cone for pusher centrifuges was developed and patented by Ferrum. Depending on the application separate external pre-thickening is not required. Fluctuating feed concentrations are compensated, cake formation is improved and the product is accelerated more gently. Today for certain applications the integrated thickening cone is our standard.

## 2. STATIC THICKENER

---

The static thickener is used if the sedimentation characteristics of the solids and the space available permit. The thickened suspension can be supplied to several centrifuges at the same time via the Ferrum dosing device.

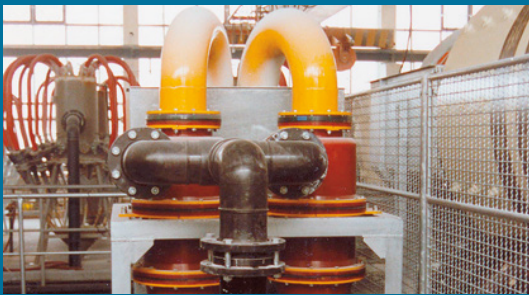
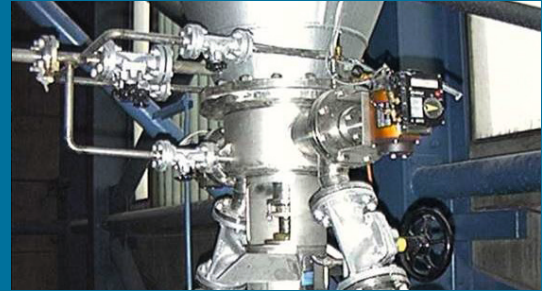

## 3. HYDROCYCLONE

---

Solids and liquid are separated by centrifugal acceleration. The thickened suspension in the outlet at the base is fed to the centrifuge. To use a hydrocyclone the density of the solids must be higher than that of the mother liquor (as with the static thickener).

## 4. CURVED SIEVE

---

The suspension is fed onto the curved sieve surface under pressure. During this process a part of the liquid is separated through the sieve slots. The thickened suspension is collected at the end of the sieve and fed to the centrifuge.

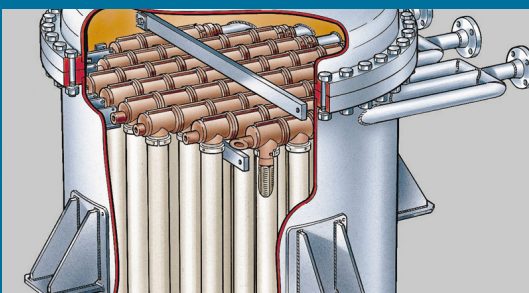

## 5. CARTRIDGE FILTER

---

Pre-thickening is achieved by the pressure difference at the cartridge filters (normally by overpressure) which are in a closed vessel. Cartridge filters operate discontinuously. To achieve a continuous process, the thickened suspension is collected in a collection tank before feeding the centrifuges.

# DOSING DEVICES AND AGITATORS

## TROUBLE-FREE FEED

### DOSING DEVICES (DAU)

---

The dosing devices with integrated agitator designed by Ferrum are installed at the discharge opening of the static thickening tank. Depending on the model, a maximum of four outlets can be realised per dosing device to permit simultaneous feeds of up to four centrifuges.

The integrated dosing valves can be actuated manually, electrically or pneumatically to control the suspension feed rate to each centrifuge.

An agitator integrated into the dosing device prevents solid deposits as well as blockages in the suspension outlets. Agitators and dosing valves are cleaned with liquid via flush connections. Connection to the customer's or Ferrum's control system permits optimally matched control of the devices.

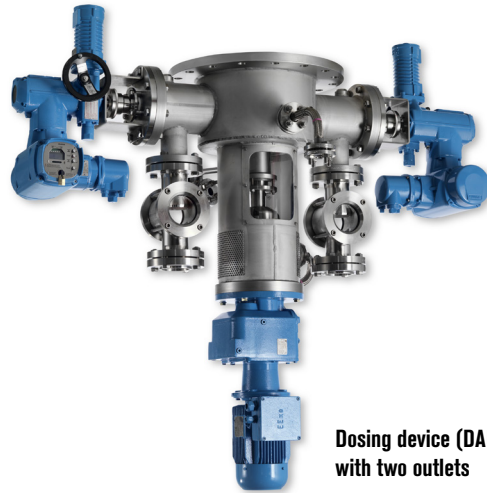

**Dosing device (DAU)  
with two outlets**



### AGITATORS (RW)

---

The agitator has a similar layout to the dosing device, however it is not equipped with integrated dosing valves. Suitable standard dosing valves can be fitted to the suspension outlets and controlled by the customer's or Ferrum's control system.



# AUTOMATION SYSTEMS

## RELIABLE CONTROL

Centrifuges place high demands on their control systems, especially with regard to the design of the power components and the use of safety sensors and controls. Ferrum has many years of experience in this field, especially with customer-specific solutions. We rely on well-known manufacturers with proven components. Current and future-oriented technologies are used, which guarantee a long life cycle of the control components.

### OUR RANGE OF SERVICES FOR PUSHER CENTRIFUGES

- + Risk and safety analyses and calculations
- + Consulting services for the design of your control system
- + Planning, execution and commissioning of the control system
- + Integration of process automation (integration of customer plant components)
- + Secure, VPN-based remote maintenance
- + Flexible connection options to distributed control systems
- + Compliance with international standards and guidelines
- + Complete and comprehensive documentation: electrical documentation, layout, concept and control descriptions, manuals, safety certificates.

### SAFETY CONTROL SYSTEMS AND CONTROL CABINETS: COMPACT OR COMPLEX: INDIVIDUAL DEPENDING ON THE APPLICATION

Our safety control systems in combination with proven power controls for our pusher centrifuges guarantee reliable and safe operation. Our portfolio ranges from basic safety controls with interfaces to customer controls, to compact controls for smaller pusher centrifuges, to our full version which, in addition to controlling the centrifuge itself, also enables the integration and control of customer peripherals.

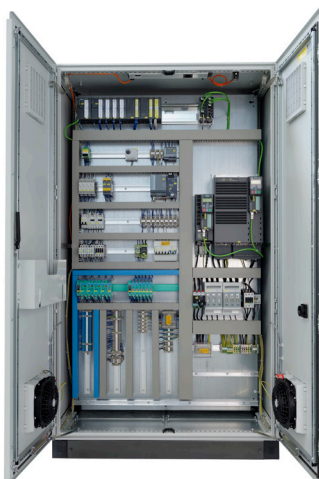

### HUMAN MACHINE INTERFACES (HMI)

Our philosophy is to offer the operator of the centrifuge a simple, clear, but at the same time comprehensively informative and intuitive interface. In doing so, we focus on using proven elements that many operators are already familiar with from process automation and distributed control systems. Depending on the requirements profile, we offer different operator panels that can be used with all our control systems.



Operator panel with visualisation



Operator panel with push buttons

# CUSTOM BUILT PRODUCT SPECIFIC DESIGNS

With over 80 years of experience in solid/liquid separation, Ferrum has a lot to offer and share to the benefit of its clients. The available operation data has been carefully gathered and evaluated so that our know-how for each specific product can be used to adapt the basic centrifuge design to the particular characteristics of different applications. Depending on the process and on the product, different factors can influence the separation step, which ultimately have an impact on the residual moisture, the product purity, crystal breakage, solids losses in the filtrate, as well as availability, stable running conditions and general wear and tear of the centrifuge.

Ferrum uses this data base to design its pusher centrifuges specifically to achieve the best possible operating results for distinct individual products. An off-the shelf unit may function but we can help our clients get the best possible out of our centrifuge.

## FERRUM HAS DEVELOPED SPECIFIC DESIGNS FOR PRODUCTS SUCH AS

---

- + Adipic acid
- + Chlorates and perchlorates
- + Nitrocellulose and other fibrous products
- + Lithium salts
- + Calcium tartrate
- + Sodium cyanide
- + Ammonium sulphate
- + Sodium sulphate

to mention the most frequently used.

## SPECIAL INDIVIDUAL FEATURES USED INCLUDE SPECIFIC DESIGNS FOR THE

---

- + sieve configuration and surface finish
- + solids discharge area
- + bearing and housing seals
- + suspension feed systems
- + housing design
- + rinsing systems
- + wear protection
- + baskets
- + material of construction

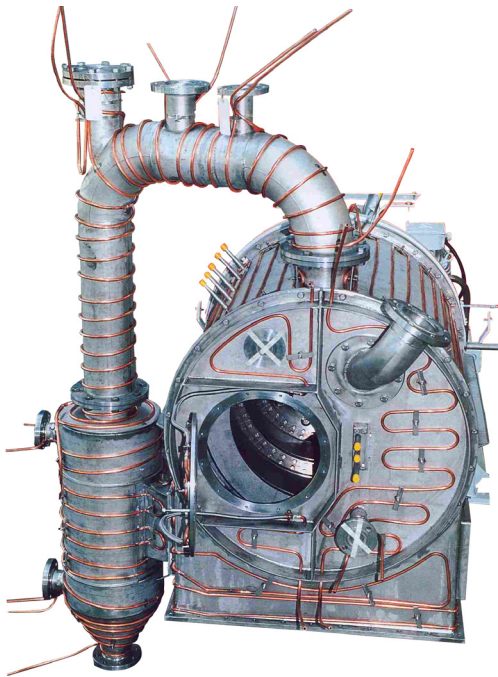

**Centrifuge with heat tracing for temperature control**



**Centrifuge design specific for fibrous products**

**FERRUM HAS AN INDIVIDUAL  
CENTRIFUGE DESIGN  
FOR YOUR APPLICATION.**

**BENEFIT FROM OUR EXPERIENCE.**

## WORLDWIDE



- MAIN OFFICES
- SERVICE CENTRES
- REPRESENTATIVES